



Power Vector Mixer

Model VMIX

Installation and Use Manual

Notice

Every effort was made to ensure that the information in this guide was complete and accurate at the time of printing. However, information is subject to change.

Important Safety Information

WARNING: To Reduce The Risk of Fire Or Electric Shock, Do Not Expose This Apparatus To Rain Or Moisture.

Always follow these basic safety precautions when installing and using the unit:

1. Read these instructions.
2. Keep these instructions.
3. Heed all warnings.
4. Follow all instructions.
5. Do not use this apparatus near water. The apparatus shall not be exposed to dripping or splashing and no objects filled with liquids, such as vases, shall be placed on the apparatus.
6. Clean only with dry cloth.
7. **DO NOT** block any ventilation openings. Install in accordance with the manufacturer's instructions.
8. Do not install near any heat sources such as radiators, heat registers, stoves, or other apparatus (including amplifiers) that produce heat.
9. Do not defeat the safety purpose of the polarized or grounding-type plug. A polarized plug has two blades with one wider than the other. A grounding-type plug has two blades and a third grounding prong. The wide blade, or the third prong, are provided for your safety. If the provided plug does not fit into your outlet, consult an electrician for replacement of the obsolete outlet.
10. Protect the power cord from being walked on or pinched, particularly at plugs, convenience receptacles, and the point where they exit from the apparatus.
11. Only use attachments/accessories specified by the manufacturer.
12. Unplug this apparatus during lightning storms or when unused for long periods of time.
13. Refer all servicing to qualified service personnel. Servicing is required when the apparatus has been damaged in any way, such as power supply cord or plug is damaged, liquid has been spilled or objects have fallen into the apparatus, the apparatus has been exposed to rain or moisture, does not operate normally, or has been dropped.

IMPORTANT



CAUTION: TO PREVENT THE RISK OF ELECTRIC SHOCK, DO NOT REMOVE COVER (OR BACK). NO USER-SERVICEABLE PARTS INSIDE. REFER SERVICING TO QUALIFIED PERSONNEL.



The lightning flash with arrowhead symbol, within an equilateral triangle, is intended to alert the user to the presence of uninsulated "dangerous voltage" within the product's enclosure that may be of sufficient magnitude to constitute a risk of electric shock to persons.



The exclamation point within an equilateral triangle is intended to alert the user to the presence of important operating and maintenance (servicing) instructions in the literature accompanying the appliance.

Contents

	Page(s)
PANEL DESCRIPTIONS.....	2-3
VMIX Front Panel	2
VMIX Rear Panel.....	3
INSTALLATION	4
Package Contents	4
Mounting	4
<i>Rack Mounting</i>	4
<i>Shelf/Table Mounting</i>	4
Module Installation	4
MODULES	5
Output Modules	5
<i>Functionality</i>	5
Input Modules	5
<i>Functionality</i>	5
<i>Priorities</i>	5
CONNECTIONS	6-7
Unbalanced Output	6
Balanced Output	6
Remote Volume Control	6
Bridging	6
Mute Control	7
System Expansion of Power Vector Mixers	7
OPERATION	8-9
Front Panel Controls & Indicators	8
<i>Input Volume Controls and Signal / Clip Indicator</i>	8
<i>Bass and Treble Controls</i>	8
<i>Master Volume Control</i>	8
<i>Average/Peak Switch & LED Output Meter</i>	8
<i>Power Switch / Power Indicator</i>	8
Rear Panel Controls	9
<i>Balanced Out Switch</i>	9
Other Controls	9
<i>Tone Control Bypass Switch</i>	9
<i>Low-Cut Switch</i>	9
BLOCK DIAGRAM	10
SPECIFICATIONS	11
ACCESSORIES	12
LIMITED WARRANTY	13

Panel Descriptions

VMIX Front Panel

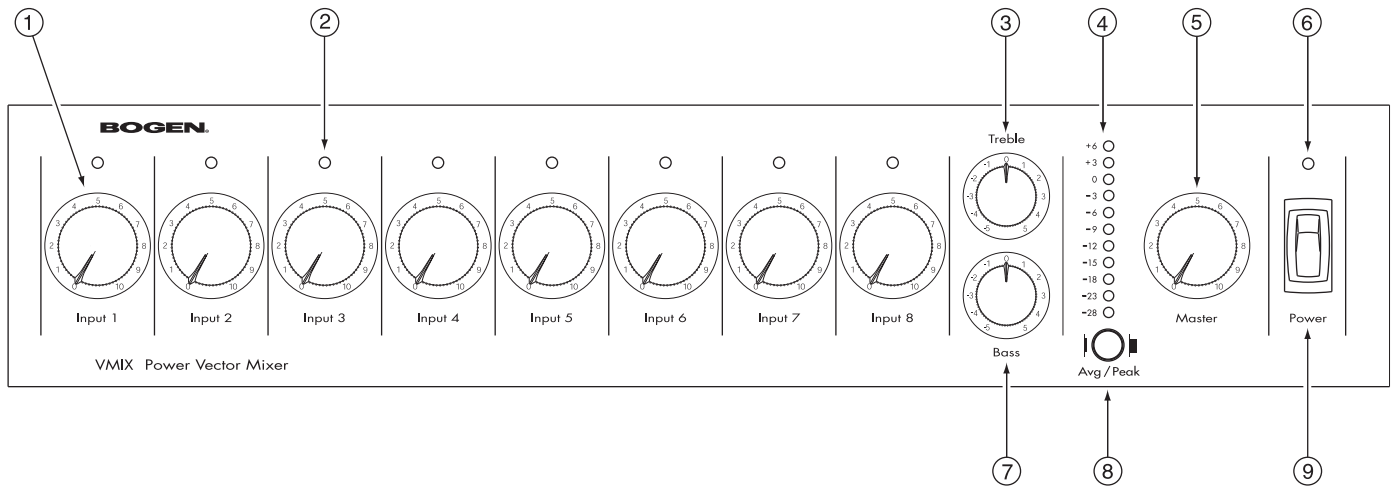

1. Input Volume Controls

Each of the 8 inputs is controlled by an independent volume control.

2. Signal / Clip Indicators

A single two-color LED located above each channel's volume control indicates the audio activity of that channel's input. Green indicates signal present at the input; red indicates clipping of the input signal.

3. Treble Control

Controls the amount of cut or boost of treble frequencies above 10 kHz.

4. LED Output Meter

An 11-segment LED output level meter monitors the output level of the mixer.

5. Master Volume Control

Controls overall level of mixed input signals.

6. Power Indicator

An LED indicates AC power status.

7. Bass Control

Controls the amount of cut or boost of bass frequencies below 100 Hz.

8. Average/Peak Switch

This switch determines whether the LED Output Meter registers the average or peak level of the mixer's output.

9. Power Switch

Controls AC power to the mixer.

Panel Descriptions

VMIX Rear Panel

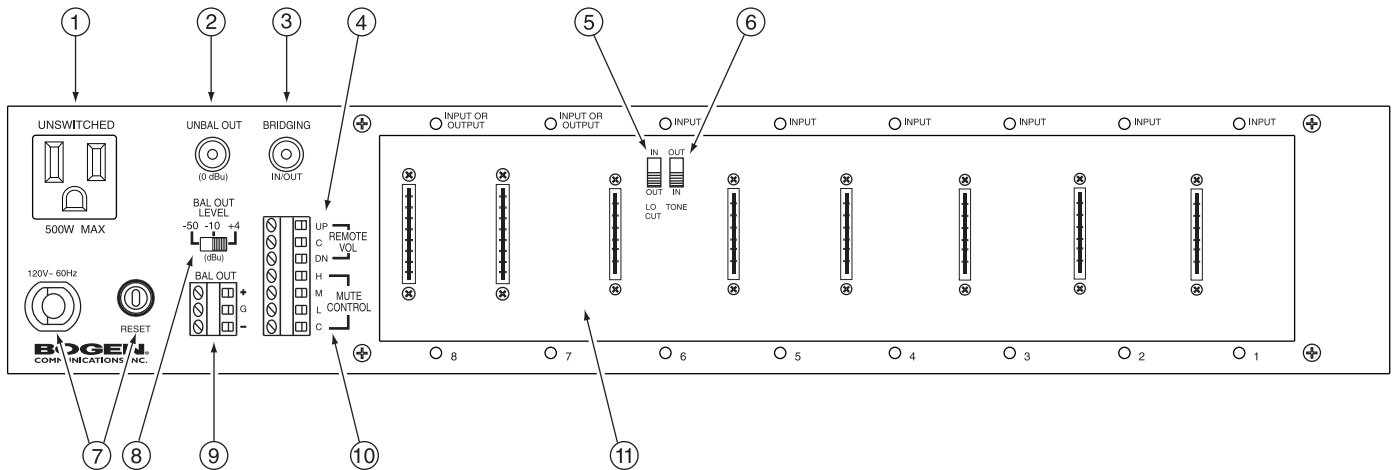

1. AC Receptacle

A grounded, unswitched AC convenience receptacle with a 500W maximum capacity is provided for external equipment.

2. Unbalanced Output Jack

Provides an unbalanced output for connection to an auxiliary or high-impedance input.

3. Bridging Jack

An RCA connector that allows the bridging of Power Vector products together for system expansion.

4. Remote Volume Control Terminals

Three terminals are provided for connection to a Bogen Model RVCP, Remote Volume Control Panel, to control the mixer's motorized Master Volume Control.

5. Low-Cut Switch

A slide switch (located in module bay 6) that allows roll off of frequencies below 125 Hz.

6. Tone Control Bypass Switch

A slide switch (located in module bay 6) that allows the effects of the bass and treble controls to be bypassed.

7. AC Line Cord and Circuit Breaker

A grounded, 3-wire AC line cord provides power to the mixer and is protected by a resettable circuit breaker.

8. Balanced Out Level Switch

Three-position slide switch that selects the signal level of the balanced output.

9. Balanced Out Terminals

Provides a balanced transformer-isolated output with selectable output levels.

10. Mute Control Terminals

Provides access to mute buses for external control and system expansion.

11. Module Bays

The mixer has eight module bays, all of which can accommodate input modules, with two bays (bays 7 and 8) that can accommodate either input or output modules.

Installation

Package Contents

- Power Vector Mixer
- Instruction Manual
- Module Covers (8)
- 12 mm Module Cover Screws (16)

Mounting

Rack Mounting

When stacking equipment in a rack, the mixer should either be on the bottom of the stack or above equipment that does not produce heat. A rack mount bracket kit (model RPK87) is available for the Power Vector mixer.

Shelf/Table Mounting

When using a shelf or table mount, the mixer should stand alone with no equipment on top of it or below it. If the mixer must be stacked with other equipment, care must be taken to ensure that all the minimum clearance distances are met and that the equipment below the mixer produces little significant heat. Rubber feet are installed on the mixer to allow it to be placed on a tabletop.

Module Installation

Eight module bays are available to accept Bogen's new advanced input modules. Module bays 7 & 8 can also accommodate Bogen's new advanced output modules, thereby allowing users to customize the mixer to suit the needs of the installation. (The bays will not accept Bogen's older style plug-in modules.)

Before installing a module, read the instructions included with the module and make the desired jumper setting changes.

The modules are installed by simply sliding them along the card guides inside the module bays until the faceplate firmly sits against the chassis, then use the two screws supplied with the module to secure it to the chassis.

**- CAUTION -
DO NOT FORCE MODULES**

- Modules should slide in easily.
- Output modules will not fit in bays 1-6.
- Output modules can only be installed in bays 7 & 8.
- Output modules have 8 contacts on each side.
- Input modules have 6 contacts on each side.
- Older D-Series style Bogen input modules (4½" in length) are not usable.

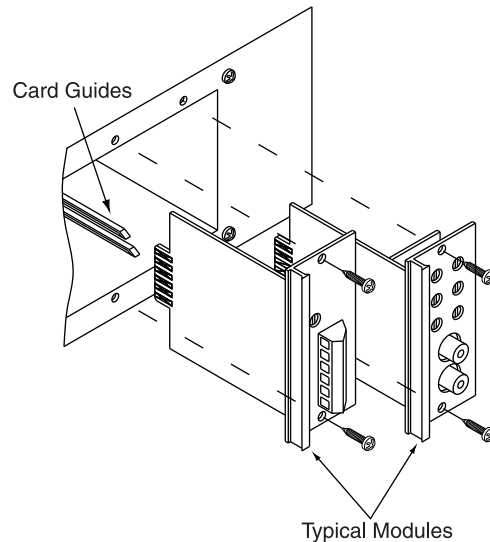

Modules

Output Modules

Functionality

The Power Vector mixer accepts Bogen signal-processing output modules, which offer a cost effective and convenient way to add specific signal-processing capability into a system. When an output module is installed, the mix bus signal is automatically rerouted through the output module, whose capabilities further process the signal before it is presented to the power mixer section.

Up to 2 output modules can be installed in a Power Vector mixer using module bays 7 & 8 (these bays accept either output or input modules). When two output modules are installed, their signal-processing effects are cascaded. The mix bus signal will first pass through the output module in module bay 7 and then through the output module in bay 8. In some instances, the order in which the signal processing is applied is important and can be determined by the module installation order.

Output modules automatically insert themselves into the signal path between the mix bus and the mixer output, so no further connections are required beyond simply inserting the modules. Most Bogen output modules include an unbalanced, Hi-Z input. This input feeds directly to the mixer's mix bus through the front level control for the particular module bay and is not processed by the output module directly. The input is included so that the input function of the module bay is not lost when an output module is installed.

Input Modules

Functionality

The Power Vector mixer accepts Bogen's new advanced input modules, which provide a wide range of input types allowing the mixer inputs to be custom configured in both type and number for a particular application. Input modules can be installed into any of the 8 module bays and do not have to be installed in any particular bay order. The front panel volume control for that number bay will control the mix level of that input module. In addition to a host of module specific features, each input module has a priority jumper section for creating a priority hierarchy between different modules installed in the mixer.

Priorities

The Power Vector mixer allows inputs to be prioritized at four different levels. The Bogen input modules contain circuitry that can cause their outputs to be muted in response to higher priority control signals from other input modules. Each input module also contains circuitry that sends a mute control signal out to other modules when it becomes active (all input modules become "active" when they receive an audio input). Active modules may be prevented from sending their audio onto the mix bus by a higher priority module that is also active.

Input priorities are set through a simple jumper field on the module. It is also possible not to assign a priority level to an input module. By doing so, that module will never be muted by another input module in the mixer.

Connections

Unbalanced Output

The VMIX includes an unbalanced output for connection to an auxiliary or high-impedance input using an RCA connector. Output level is 0 dB μ when meter reads "0". Maximum output is +20 dB μ .

UNBAL OUT



Balanced Output

Three terminals are provided for the transformer balanced output of the Power Vector mixer.

Note: The output signal level is selectable for +4 dB μ , -10 dB μ , or -50 dB μ (see Page 9).

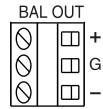
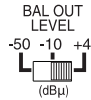

Remote Volume Control

Three terminals are provided for remote control of the Master Volume control on the front panel. This control is motorized, allowing full control over the setting of the master volume. Shorting the UP terminal with the C terminal will rotate the Master Volume control in a clockwise direction, increasing the volume level. Shorting the DN terminal to the C terminal will cause the Master Volume control to rotate in a counter-clockwise direction and decrease the level of the Master Volume control. The impedance of the shorting connections must be less than 100 ohms in order to operate the control. The Bogen Remote Volume Control Panel (Model RVCP) provides a simple and elegant means of remote control. Alternatively, a SPDT spring-loaded, center off switch or two SPST push-button switches can provide the necessary contacts for remote control.

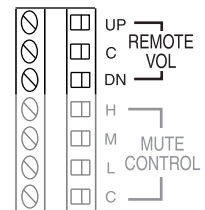

Bridging

This connector makes the Power Vector's mix bus available externally and allows the connecting of Power Vector products for system expansion and simple room combining.

This function is bi-directional. Any signal received will be amplified and any signal sent can be used by another Power Vector product. The signal levels at the bridging jack will drop by one-half with two Power Vectors tied together and by two-thirds with three units tied together. Because of the attenuation of the bridging signal, due to the signal loading of other Power Vectors, it is not recommended that more than three units be connected together. See *Mute Control* section and the illustration on next page for additional information.

BRIDGING



Connections

Mute Control

Each priority bus (High, Medium, and Low) can be externally activated. This allows priority buses of two or more Power Vector products to be linked together for system expansion purposes. A particular mute priority can be externally forced by shorting that priority's bus terminal to the C terminal of the Mute Control (the C terminal is the system ground). Forcing the H priority bus this way will mute all modules except for modules set for priority level 1 (highest priority). Forcing the M priority bus will mute modules set for priority levels 3 or 4, but not levels 1 or 2, and forcing the L priority bus will only mute modules set at priority level 4.

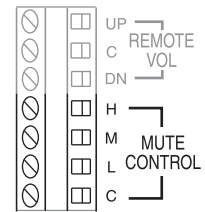

System Expansion of Power Vector Products

By interconnecting the Bridging Connector and Mute Control lines, it is possible to connect two or more Power Vector units into a larger integrated system. Wire the bridging jack and mute control lines as shown in the diagrams for bridging either 2 or 3 units together. The overall system gain of Power Vector products diminishes when they are bridged because each unit's mix bus loads down the other product's bus. When bridging two Power Vector products, the system gain drops by about 6 dB. When bridging 3 Power Vector units together, the system gain drops by approximately 12 dB. It is important to make sure that the input module or that the input signal source itself has enough level to make up for the bridging loss otherwise the products may not be able to reach their full rated output.

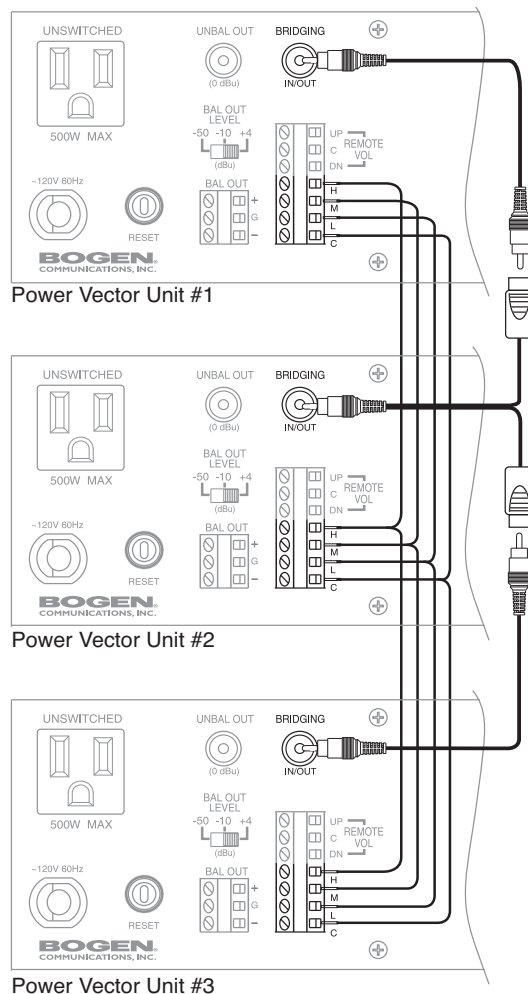

Note: Bridging can be any combination of Power Vector Mixers and/or Amplifiers.

Bridging more than 3 Power Vector units together is not recommended because of bridging losses.

Operation

Front Panel Controls & Indicators

Input Volume Controls and Signal / Clip Indicator

Each input module may be individually controlled by its corresponding volume control knob. A single LED located above each channel's volume control indicates the audio activity of that channel's input. Green indicates signal present at the input. Red indicates that the input signal coming from the input module into the mixer is clipping and distorted. This is caused by either an input signal that is too high or an input module volume control (gain) that is set too high.

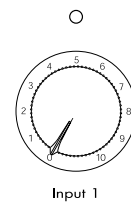

Bass and Treble Controls

The treble control has a cut/boost range of +/- 10 dB at frequencies above 10 kHz and provides a roll off after 20 kHz to reduce gain above the audio range. The bass control has a cut/boost range of +/- 10 dB at frequencies below 100 Hz.

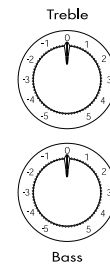

Master Volume Control

The overall volume level of the mixer is set by a Master Volume control. The Master Volume control is motorized and can be controlled by manually adjusting the knob or by a remotely-mounted control station. Connections and requirements for the remote control station are described in the *Connections* section, under *Remote Volume Control*.

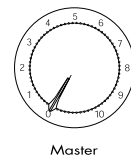

Average/Peak Switch & LED Output Meter

The LED Output Meter is an 11-segment meter that registers either the average or the peak level of the mixer's output signal. The meter can be set to read either the average output signal (button in) or the peak output signal levels (button out) by using the Avg/Peak button at the bottom of the meter.



Power Switch / Power Indicator

The AC power to the amplifier is controlled by the Power rocker switch. A red LED indicator lights to confirm the power on status of the mixer.



Operation

Rear Panel Controls

Balanced Out Switch

A three-position slide switch selects the signal level of the balanced output. Output levels of +4 dB μ , -10 dB μ , and -50 dB μ are available. The indicated output level corresponds to "0" on the level meter.

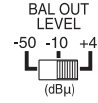

Other Controls (Located In Module Bay 6)

Tone Control Bypass Switch

A slide switch that can bypass the effects of the Bass and Treble controls is located on the back plane of module bay 6. It is sometimes desirable to bypass the tone controls when other forms of system equalization are used. A screwdriver can be used to set the switch. The switch must be set before a module is installed in this bay.

Low-Cut Switch

The Power Vector mixer provides a low-cut filter that rolls off frequencies below 125 Hz. The slide switch for this function is located on the back plane of module bay 6. A screwdriver can be used to set the switch. The switch must be set before a module is installed in this bay.

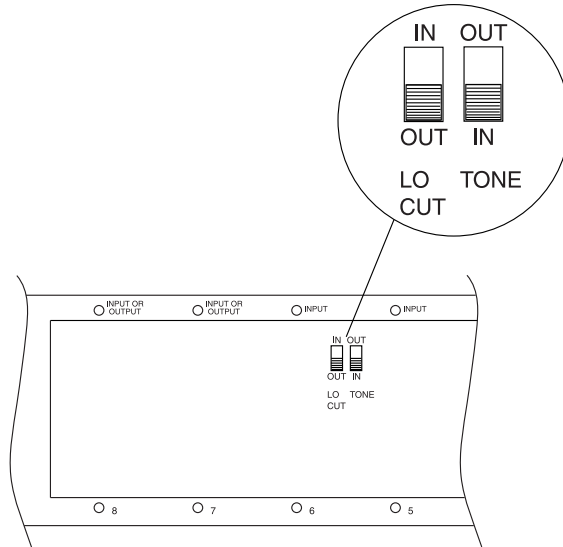

Block Diagram

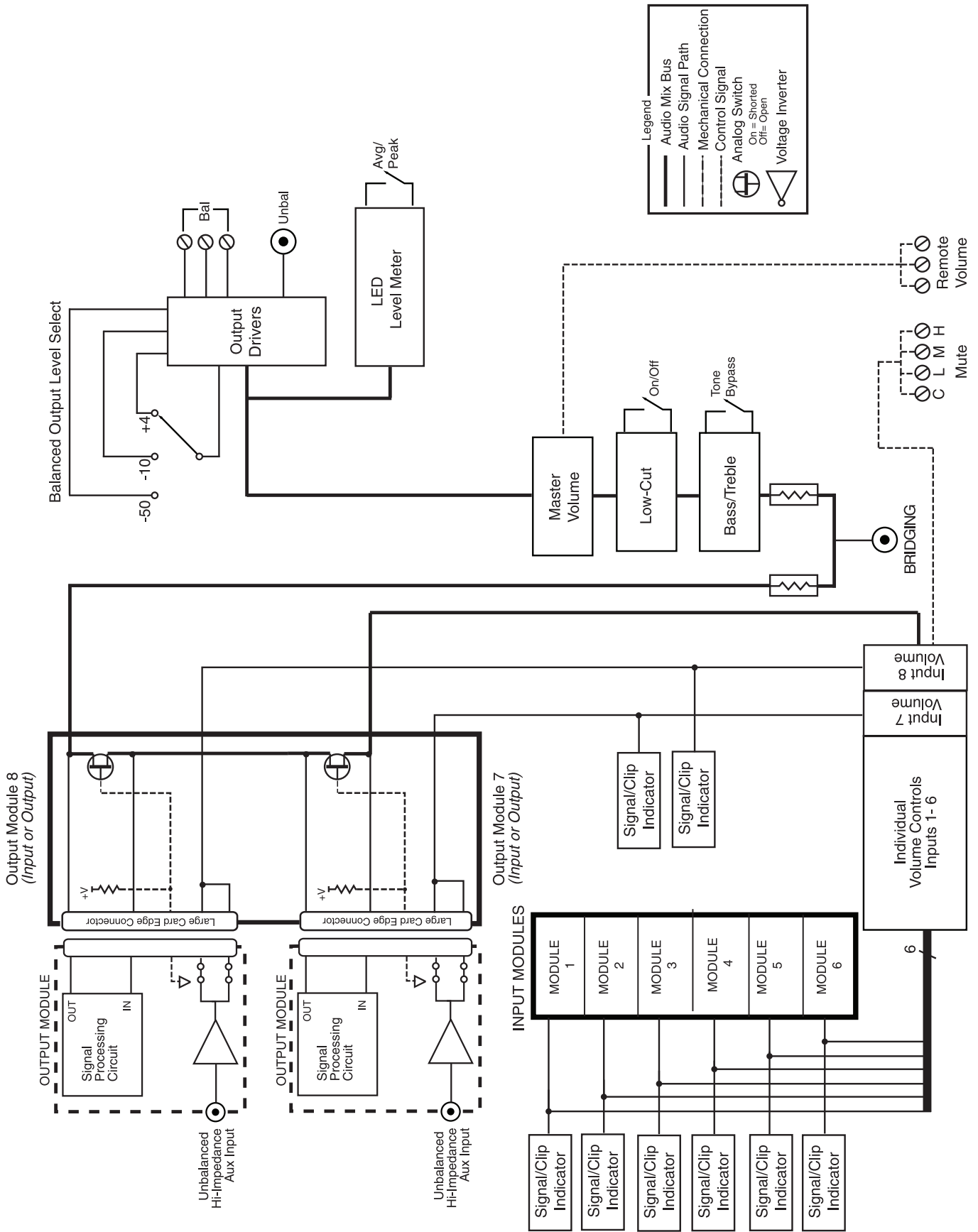

Specifications

Output Level

Balanced: Selectable +4, -10, -50 dB μ (typical when meter reads "0")

Unbalanced: 0 dB μ (typical when meter reads "0")

Max. Output Level

Balanced: +18 dB μ

Unbalanced: +20 dB μ

Frequency Response: +/- 1 dB (20 Hz to 20 kHz)

Distortion: 0.01 (@ +18 dB μ THD+N, 20 Hz to 20 kHz BW Limited)

Signal-to-Noise

Fundamental: -99 dB*

w/ AUX MAX1R Module: -94 dB*

w/ MIC2X Module: -64 dB*

w/ TEL1S Module: -92 dB*

Tone Controls

Bass Frequency: 100 Hz (+/- 10 dB minimum)

Treble Frequency: 10 kHz (+/- 10 dB minimum)

Low Cut Frequency: 125 Hz @ -6 dB/octave

Signal / Clip Indicator

Signal Detect Threshold: 10 mV @ output of module

Signal Indicator Hold Time: 50 mS (green indicator)

Clip Detect Threshold: 6V @ output of module

Clip Detect Hold Time: 50 mS (red indicator)

Output Impedance

Balanced: 50 ohms @ +4 dB μ , 600 ohms @ -10 dB μ , 5 ohms @ -50 dB μ

Unbalanced: 100 ohms

Power Consumption: 21 watts

AC Power Receptacle: 500 watts maximum power, unswitched

Dimensions: 17-1/4" W x 3-7/8" H x 14-3/4" D

Product Weight: 15 lb.

Safety Approvals: Listed to UL Standard 60065 for U.S. and Canada

* Referenced to max output level, 20 Hz to 20 kHz bandwidth limited.
All specifications subject to change without notice.

Accessories

A variety of accessories are available.

RPK87 - Rack Mounting Kit

- Adapts Power Vector Mixer for 19" rack mounting
- Heavy gauge steel construction
- Fits Power Vector Mixer into 2 rack spaces (3½")

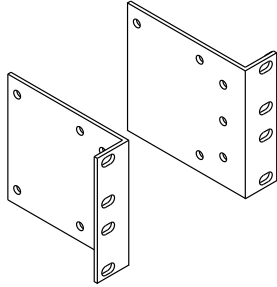

RVCP - Remote Volume Control Panel

- Push-button operation of motorized master volume control
- Fits in standard single gang electrical box
- Decora style cover plate

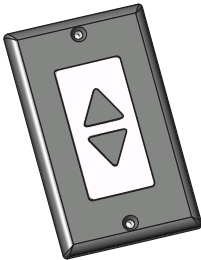

PVSC - Power Vector Security Cover

- Prevents tampering with system settings
- Power and meter switches accessible
- Simple installation

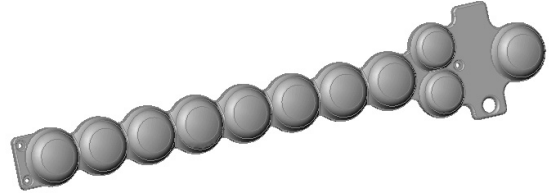

PVMC - Power Vector Module Cover

- Prevents tampering with module controls
- Adaptable for different module types
- Covers unused module slots

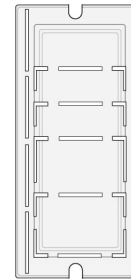

Limited Warranty; Exclusion of Certain Damages

The **Bogen VMIX** is warranted to be free from defects in material and workmanship for three (3) years from the date of sale to the original purchaser. Any part of the product covered by this warranty that, with normal installation and use, becomes defective (as confirmed by Bogen upon inspection) during the applicable warranty period, will be repaired or replaced by Bogen, at Bogen's option, provided the product is shipped insured and prepaid to: Bogen Factory Service Department, 50 Spring Street, Ramsey, NJ 07446, USA. Repaired or replacement product will be returned to you freight prepaid. This warranty does not extend to any of our products that have been subjected to abuse, misuse, improper storage, neglect, accident, improper installation or have been modified or repaired or altered in any manner whatsoever, or where the serial number or date code has been removed or defaced.

THE FOREGOING LIMITED WARRANTY IS BOGEN'S SOLE AND EXCLUSIVE WARRANTY AND THE PURCHASER'S SOLE AND EXCLUSIVE REMEDY. BOGEN MAKES NO OTHER WARRANTIES OF ANY KIND, EITHER EXPRESS OR IMPLIED, AND ALL IMPLIED WARRANTIES OF MERCHANTABILITY OR FITNESS FOR A PARTICULAR PURPOSE ARE HEREBY DISCLAIMED AND EXCLUDED TO THE MAXIMUM EXTENT ALLOWABLE BY LAW. Bogen's liability arising out of the manufacture, sale or supplying of products or their use or disposition, whether based upon warranty, contract, tort or otherwise, shall be limited to the price of the product. **IN NO EVENT SHALL BOGEN BE LIABLE FOR SPECIAL, INCIDENTAL OR CONSEQUENTIAL DAMAGES (INCLUDING, BUT NOT LIMITED TO, LOSS OF PROFITS, LOSS OF DATA OR LOSS OF USE DAMAGES) ARISING OUT OF THE MANUFACTURE, SALE OR SUPPLYING OF PRODUCTS, EVEN IF BOGEN HAS BEEN ADVISED OF THE POSSIBILITY OF SUCH DAMAGES OR LOSSES.** Some States do not allow the exclusion or limitation of incidental or consequential damages, so the above limitation or exclusion may not apply to you. This warranty gives you specific legal rights, and you may also have other rights which vary from State to State.

Products that are out of warranty will also be repaired by the Bogen Factory Service Department – same address as above or call 201-934-8500. The parts and labor involved in these repairs are warranted for 90 days when repaired by the Bogen Factory Service Department. All shipping charges in addition to parts and labor charges will be at the owner's expense. All returns require a Return Authorization number. For most efficient warranty or repair service, please include a description of the failure.

12/2008

BOGEN[®]
COMMUNICATIONS, INC.

50 Spring Street, Ramsey, NJ 07446, U.S.A.
Tel. 201-934-8500 • Fax: 201-934-9832

www.bogen.com